

HV/HVG SEALED SERIES for STANDARD

1.0mm (040)

Structure

D-02

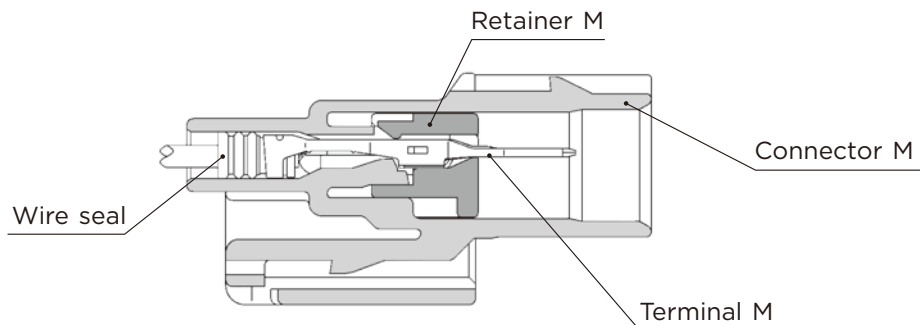

Connector M

Connector F

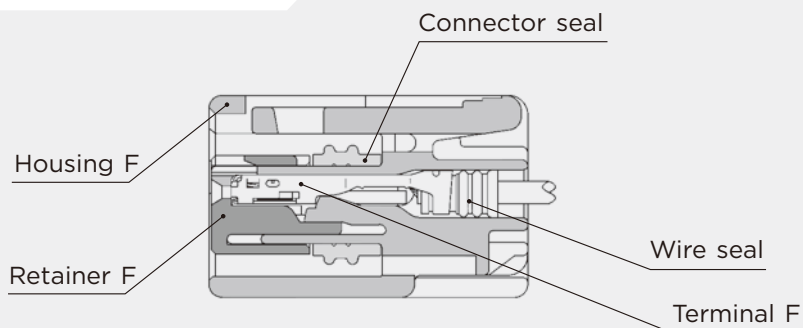

1.0mm (040)

Terminal (UNIT : mm)

Ref; 1.0mm Terminal detail

S M (8100-3177) E-03 **F** (8100-3067) E-03

M M (8100-3178) E-03 **F** (8100-3068) E-03

1.0mm (040)

Wire seals (UNIT : mm)

Ref; 1.0mm Wire Seals detail

SS (7165-1075) E-03

S (7165-0621) E-03

M (7165-0622) E-03

The wire seals are common to M and F.
ワイヤシールは、M、F 共用です。

1.0mm (040)

Dummy plugs (UNIT : mm)

Ref; 1.0mm Dummy plug detail

(7165-0432) E-04

- Dummy plugs are common to M and F.
- Dummy plugs are used to blind unused terminal holes.
- ダミー栓はM、F 共用です。
- 不必要なターミナル穴を塞ぐために、ダミー栓を使用します。

1.0mm (040)

Housing (UNIT : mm)

Ref: Terminal part No. E-02

Ref: wire seal No. E-03

Ref: Dummy plug No. E-04

Material PBT

3way

Color Black

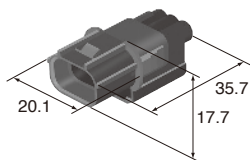

M (6188-4775)

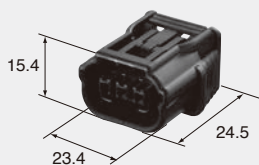

F (6189-7037)

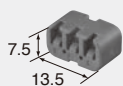

Retainer No. (6918-1833)

Color Black

2way

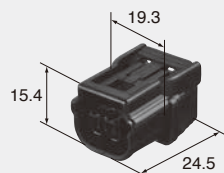

F (6189-7036)

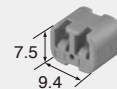

Retainer No. (6918-1835)

Color Black

2way

(Coded connector) (リブ違)

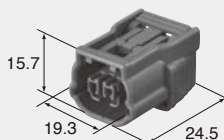

F (6189-7052)



Retainer No. (6918-1835)

Color Dark Gray

3way

(Coded connector) (リブ違)

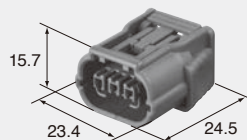

F (6189-7058)

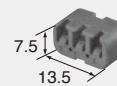

Retainer No. (6918-1833)

Color Dark Gray

4way

Color Black

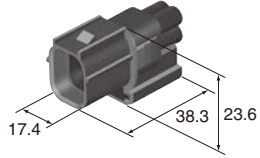

M (6188-4776)

F (6189-7039)

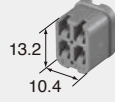
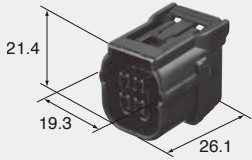

Retainer No. (6918-2810)

Color Black

5way

F (6189-6909)

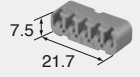
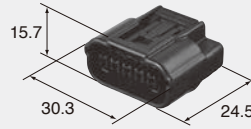

Retainer No. (6918-2128)

Color Black

6way

Color Black

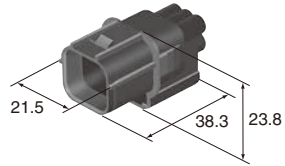

M (6188-4908)

F (6189-7040)

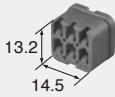
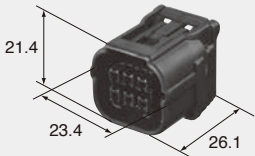

Retainer No. (6918-2913)

Color Black

10way

Color Black

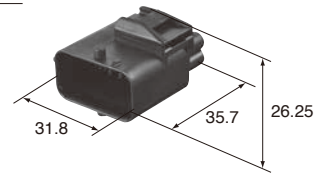
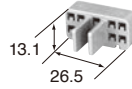

Retainer No. (6918-2804)

M (6181-6481)

F (6189-6906)

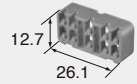
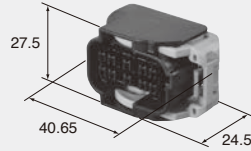

Retainer No. (6918-2806)

Color Black

D-04