

YESC

CONNECTORS

1.5 SERIES SEALED

1.5 SERIES
SEALED

CLICK ON YOUR SELECTION:

- CONSTRUCTION
- SPECIFICATIONS
- CURRENT RATING CURVE
- TERMINAL
- CABLE SEAL
- RETAINER CLIP/BRACKET DIMENSIONS
- PART NUMBER SUMMARY CHART
- PHOTOS/DIMENSIONS
- NAVIGATION TIPS



1.5 x 0.8

sealed connection system

Construction

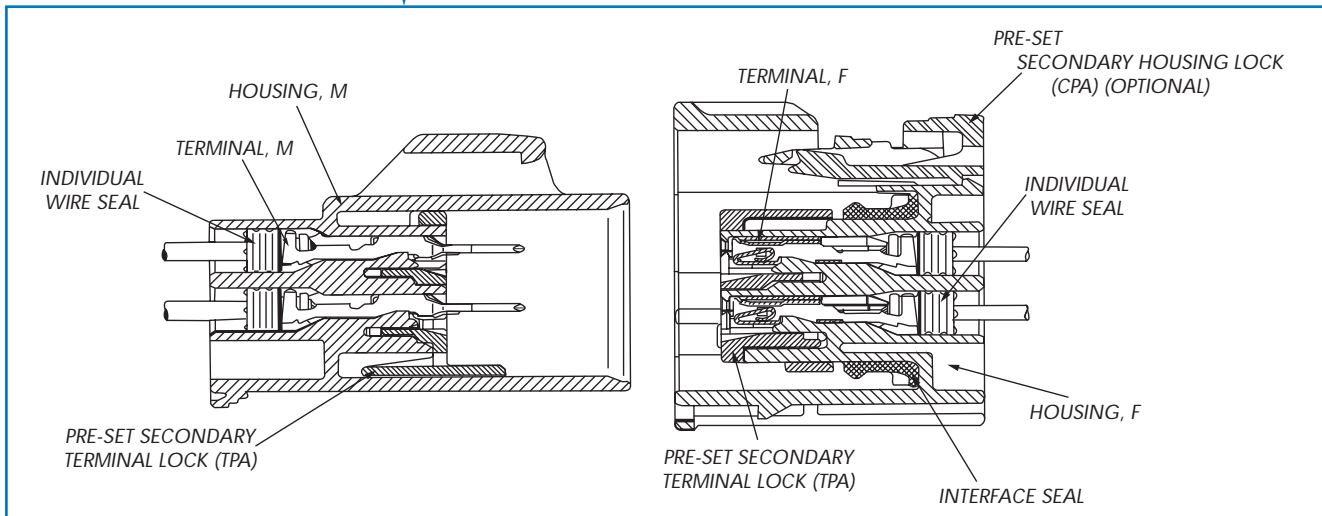

Specifications

Material	Connector	HPA
	Male Terminal	Copper Alloy (Sn/Au Plate)
	Female Terminal	Copper Alloy (Sn/Au Plate)
Operating Temperature Range		-40°C ~ 125°C (145°C max temp.) (USCAR Class III)
Current Capacity		(See Chart)
Voltage Drop		10mΩ Max (Term./Term.) (Crimp-To-Crimp)
Isolation Resistance		500VDC, 20MΩ Min
Dielectric Resistance		1000VAC (1 min.)
Applicable Wire Size		22AWG ~ 16AWG (0.35mm ² ~ 1.0mm ²)
Terminal Pitch		Horizontal: 5.50mm; Vertical: 6.50mm
Sealing Performance (Air Leak Pressure)		48kPa Min (Pre-Heat Soak); 28kPa (Post-Heat Soak)
Terminal-to-Connector Retention Force		90N Min
Connector-to-Connector Retention Force		110N Min

Current Rating Curve (Reference Only)

This data is based on single circuit/connector evaluation. Data should be used as reference only. Appropriate derating should be considered based upon specific application requirements.

0.35mm² rating curve not shown.

Current capability of terminal exceeds capacity of wire.

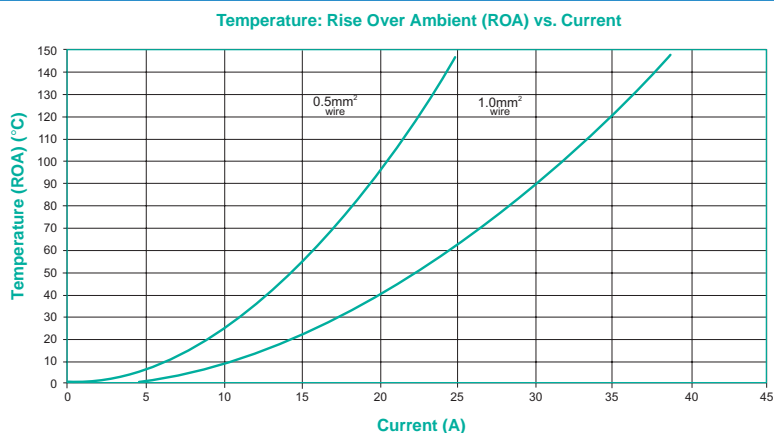

sealed connection system

1.5 x 0.8

Terminal

UNIT: mm

Male Terminal		Female Terminal			
Material: Copper Alloy Thickness: $t=0.3$		Material: Copper Alloy Thickness: $t=0.25$			
Description	Part Number	Plating	Applicable Wire Size		
			Europe (mm ²)	U.S.A. (AWG)	Japan (mm ²)
Male Terminal	7114-4102-02	Sn	0.35 ~ 0.5	22 ~ 20	0.3 ~ 0.5
	7114-4103-02	Sn	0.75 ~ 1.0	18 ~ 16	0.85 ~ 1.25
	7114-4102-08	Au	0.35 ~ 0.5	22 ~ 20	0.3 ~ 0.5
	7114-4103-08	Au	0.75 ~ 1.0	18 ~ 16	0.85 ~ 1.25
Female Terminal	7116-4102-02	Sn	0.35 ~ 0.5	22 ~ 20	0.3 ~ 0.5
	7116-4103-02	Sn	0.75 ~ 1.0	18 ~ 16	0.85 ~ 1.25
	7116-4102-08	Au	0.35 ~ 0.5	22 ~ 20	0.3 ~ 0.5
	7116-4103-08	Au	0.75 ~ 1.0	18 ~ 16	0.85 ~ 1.25

Cable Seal

UNIT: mm

Description	Part Number	Color	Material	Wire O.D. Range
Cable Seal	7158-3030-50	Red	Silicone	1.19 ~ 1.70
	7158-3031-90	Blue	Silicone	1.60 ~ 2.34
Unused Cavity Plug	7158-3032-60	Green	Silicone	N/A

Retainer Clip/Bracket Dimensions

UNIT: mm

Part Number	Panel Hole Requirements
7047-9580 (Ref.)	φ6.5mm

1.5 x 0.8

sealed connection system

Part Number Summary Chart

Part Name	Male	Female
Terminal	7114-4102-02	7116-4102-02
	7114-4103-02	7116-4103-02
	7114-4102-08	7116-4102-08
	7114-4103-08	7116-4103-08
Cable Seal	7158-3030-50	
	7158-3031-90	
Unused Cavity Plug	7158-3032-60	
Applicable Clip	N/A	7047-9580 (Ref)

Pole	Polarity	Color Description	Male Part #	Female Part #	Female Part # (w/CPA)	Delete Cap
2	A	Black	7282-5548-30	7283-5548-30	7283-5549-30	
2	B	Dark Grey	7282-5558-10			
2		Black/Direct only		7283-5689-30		
2		Dark Grey/Direct only			7283-6432-10	
2		Natural/Direct only			7283-6433	
2		Light Grey/Direct only			7283-6434-40	
3	A	Black	7282-5541-30			
3	B	Dark Grey	7282-5691-10	7283-5691-10	7283-5880-10	
3		Black/Direct only		7283-5537-30		
4	2-Row A	Dark Grey	7282-5543-10	7283-5543-10	7283-5544-10	
4	2-Row B	Black	7282-5889-30	7283-5889-30		
4	2-Row B	Blue	7282-5889-90	7283-5889-90		
5	A	Black		7283-5547-30	7283-5550-30	
6	A	Dark Grey	7282-5553-10	7283-5553-10	7283-5554-10	
6	A	Black	7282-5553-30	7283-5553-30	7283-5554-30	
8	A	Dark Grey	7282-5684-10			
8	A	Black	7282-5684-30			
10	2-Row A	Black	7282-5946-30	7283-5946-30	7283-5947-30	
10	2-Row B	Dark Grey, #1 Pin Neg.			7283-5694-10	
10	2-Row B	Light Grey, #1 Pin Neg.		7283-5948-40	7283-5694-40	
10	2-Row B	Black, #5 & #9 Pin Neg.			7283-5695-30	
10	2-Row B	Black, #1 & #5 Pin Neg.		7283-6472-30	7283-6473-30	
10	5-Row A	Black/ PBT Material		7283-6478-30	7283-6479-30	
12	A	Dark Grey	7283-5545-10	7283-5546-10	7282-5545-10	
12	A	Black	7282-5545-30	7283-5545-30	7283-5546-30	
18	A	Black	7282-6493-30	7283-6493-30		





*** Applicable Terminal Removal Tool/Dimensions**
 Refer to Page 68 for YES Connector Terminal Removal Tool.
 Order Number: X39899-J374.

sealed connection system

1.5 x 0.8

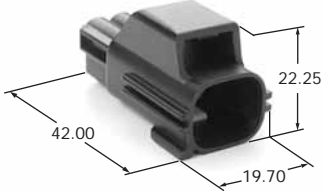
Housing Material: HPA

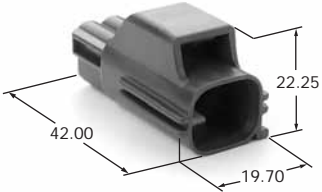
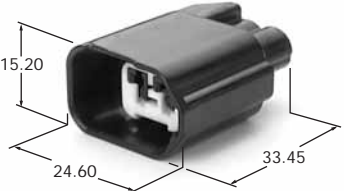
UNIT: mm

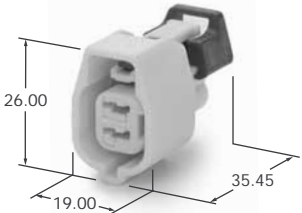
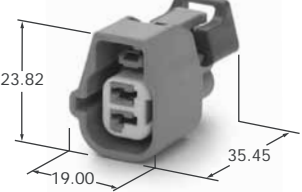



Poles	Male Housing	Female Housing
2	 <p>7282-5548-30</p>	 <p>7283-5548-30</p>
2	 <p>7282-5558-10</p>	<p>N/A Please check YESC KAIZEN Catalog for the mate.</p>
2	<p>N/A</p>	 <p>7283-5689-30</p>
2	<p>N/A</p>	 <p>7283-6432-10</p>
2	<p>N/A</p>	 <p>7283-6433</p>
2	<p>N/A</p>	 <p>7283-6434-40</p>

1.5 x 0.8

sealed connection system

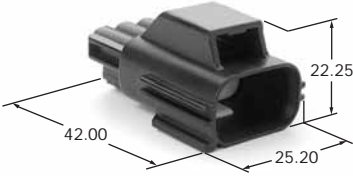
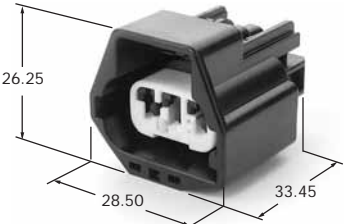
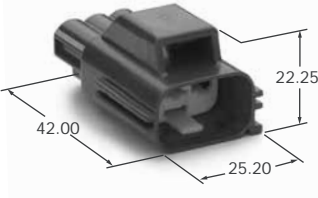
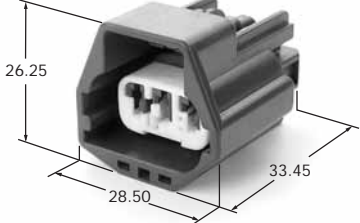
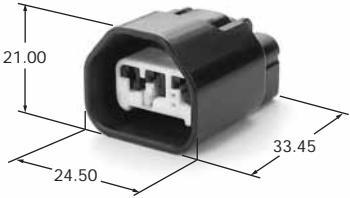
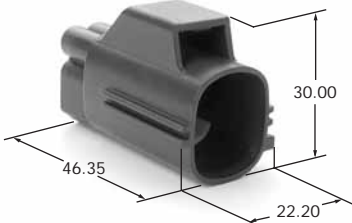
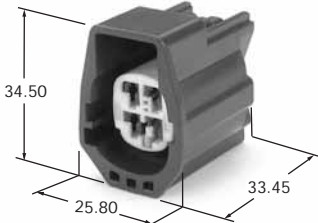
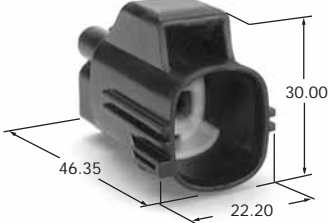
Housing Material: HPA

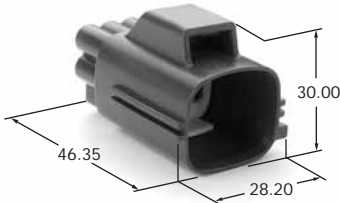
UNIT: mm

Poles	Male Housing	Female Housing
3	 <p>7282-5541-30</p>	 <p>7283-5541-30</p>
3	 <p>7282-5691-10</p>	 <p>7283-5691-10</p>
3	N/A	 <p>7283-5537-30</p>
4	 <p>7282-5543-10</p>	 <p>7283-5543-10</p>
4	 <p>7282-5889-30</p>	 <p>7283-5889-30</p>
6	 <p>7282-5553-10</p>	 <p>7283-5553-10</p>

sealed connection system

1.5 x 0.8

Housing Material: HPA

UNIT: mm

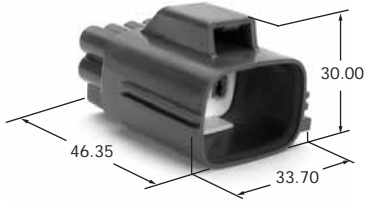
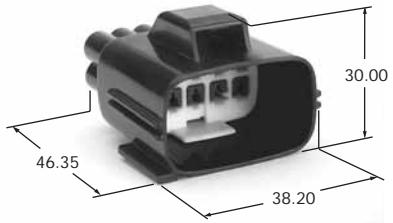
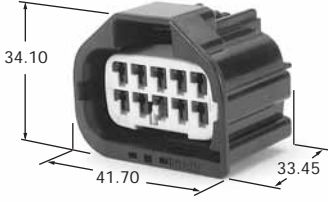
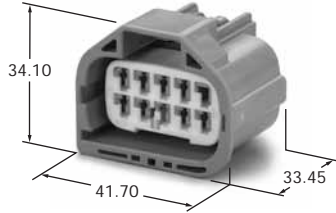
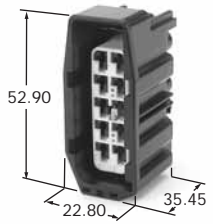
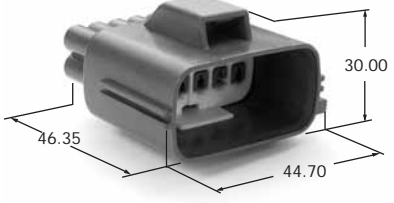
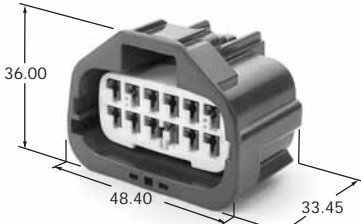
<p>8</p>	 <p>7282-5684-10</p>	<p>N/A Please check YESC KAIZEN Catalog for the mate.</p>
<p>10</p>	 <p>7282-5946-30</p>	 <p>7283-5946-30</p>
<p>10</p>	<p>N/A</p>	 <p>7283-5948-40</p>
<p>10</p>	<p>N/A</p>	 <p>7283-6478-30</p>
<p>12</p>	 <p>7282-5545-10</p>	 <p>7283-5545-10</p>

DISCLAIMER: The information contained in this catalog is for reference purposes only, is subject to change without notice, and is not guaranteed by Yazaki Corporation, Yazaki North America Inc., Yazaki Europe Limited or any other Yazaki group company (collectively referred to as "Yazaki"). Yazaki makes no warranty as to the completeness or accuracy of the information contained herein, and is not responsible for any typographical or printing errors. Current specifications for individual products should be obtained by potential customers in connection with placing orders for products with Yazaki.

The customer, among other matters, is solely responsible for determining the fitness or suitability of any product of Yazaki for the purpose intended by the customer and for all design and related matters.

Yazaki makes no warranty, express or implied, with respect to any product referred to in this catalog, except such express warranty. If any as may be specifically agreed to by Yazaki in a written agreement signed and delivered by an authorized representative of Yazaki for the sale of such product, and any such express warranty shall be the sole and exclusive liability of Yazaki. Yazaki makes no other warranty. Whether express, implied, statutory or otherwise, including but not limited to any warranty of merchantability or fitness for any particular use, purpose or otherwise with respect to such products.