

THE INFORMATION CONTAINED IN THIS DRAWING IS THE SOLE PROPERTY OF
 ONEPAC ENGINEERING, INC. AND IS TO BE USED ONLY FOR THE PROJECT AND
 FOR WHICH IT WAS PREPARED. IT IS NOT TO BE REPRODUCED OR TRANSMITTED
 IN ANY FORM OR BY ANY MEANS, ELECTRONIC OR MECHANICAL, INCLUDING
 PHOTOCOPYING, RECORDING, OR BY ANY INFORMATION STORAGE AND RETRIEVAL
 SYSTEM, WITHOUT THE WRITTEN PERMISSION OF ONEPAC ENGINEERING, INC.

REV. 1	REVISIONS	DATE	APPROVED
2	REVISIONS	DATE	APPROVED
3	REVISIONS	DATE	APPROVED
4	REVISIONS	DATE	APPROVED
5	REVISIONS	DATE	APPROVED
6	REVISIONS	DATE	APPROVED
7	REVISIONS	DATE	APPROVED
8	REVISIONS	DATE	APPROVED

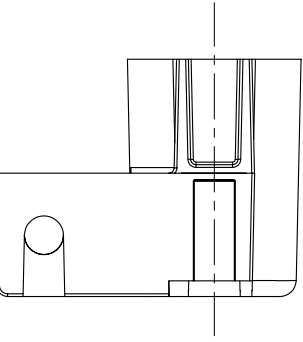
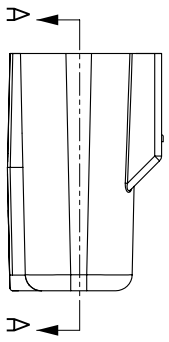
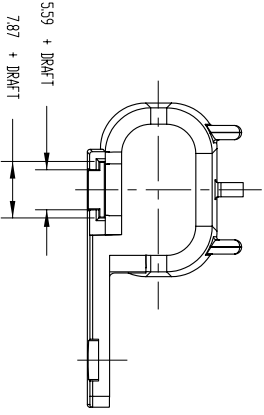
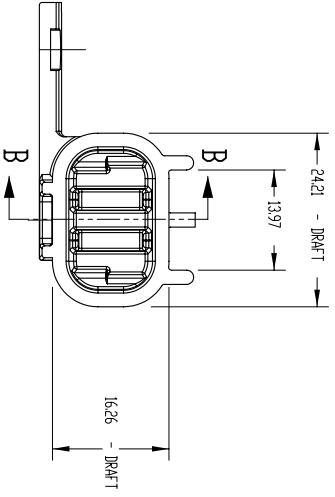
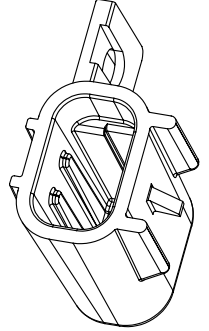
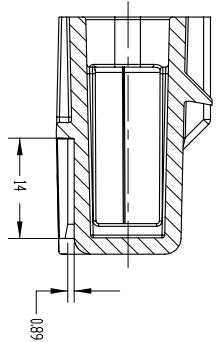
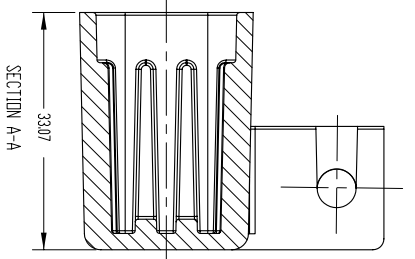
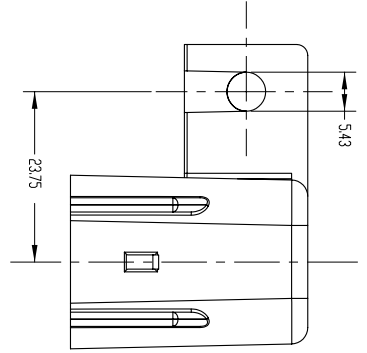

- NOTES:
 1. MATERIAL: NYLON 6/6, HEAT STABILIZED, BLACK COLOR.
 2. THIS PART MATES WITH DELPHI PACKARD 15300027 CONNECTOR.

DESIGN APPROVED		DATE	
DRAWN		DATE	
CHECKED		DATE	
MATERIAL		DATE	
SEE NOTE 1.		DATE	
NO. OF SCALE DRAWING		DATE	
J.R. GREENLEAF & CO.		DATE	
WESTLAKE OHIO 44145		DATE	
ES10 CAP		DATE	
10011		DATE	
SHEET 1 OF 1		DATE	